

# 861

600 x 480 x 2000 mm

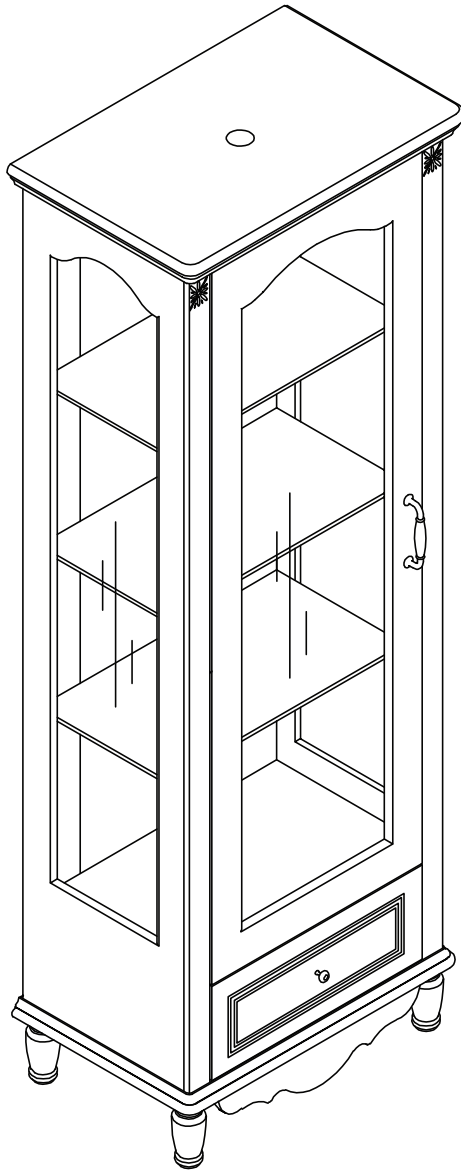

**BEMONDI**

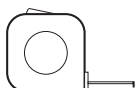
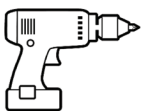
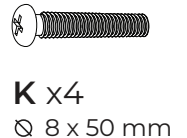
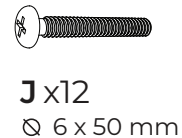
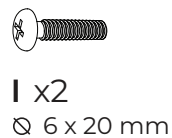
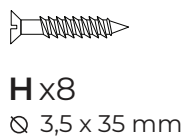
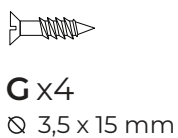
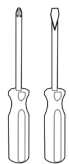
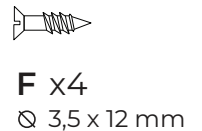
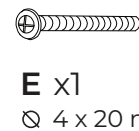
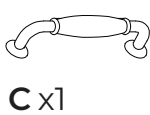
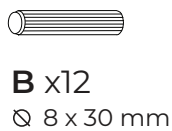
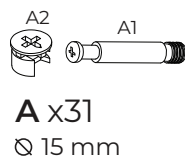
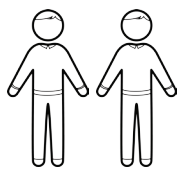
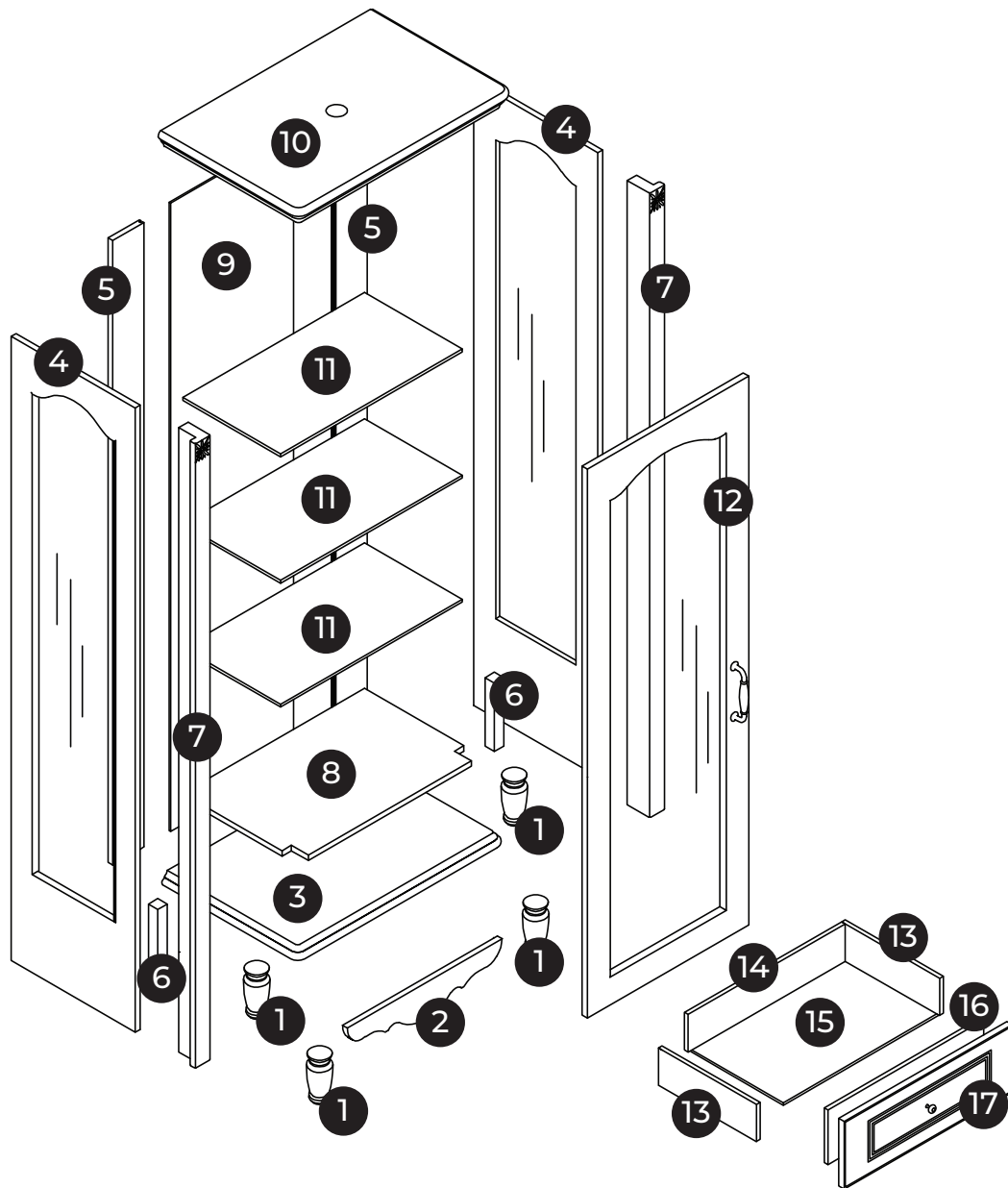

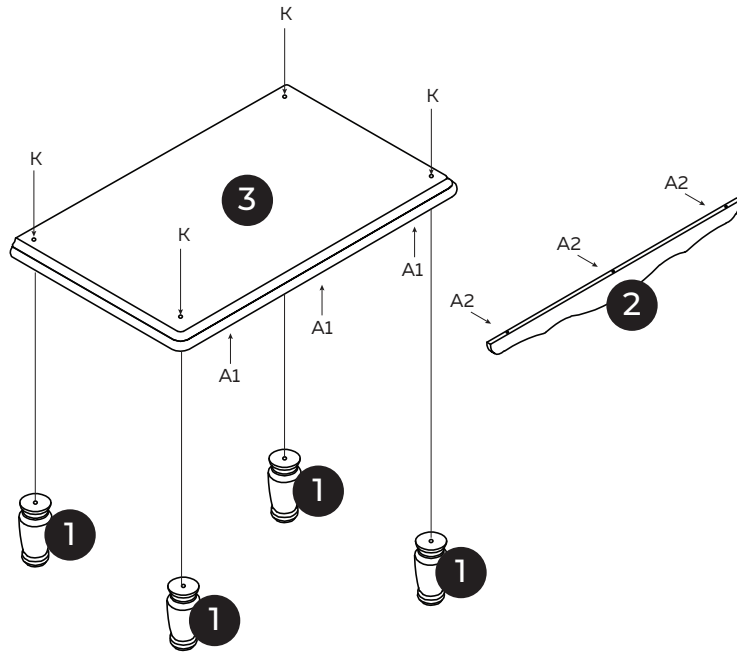
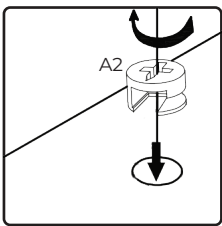
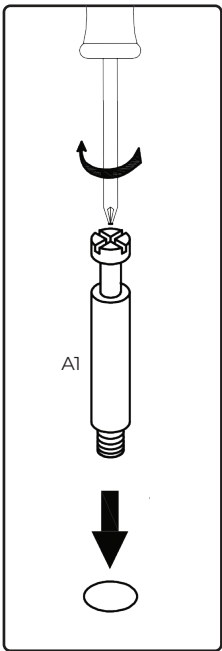

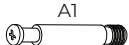
A   x3

K  x4

1

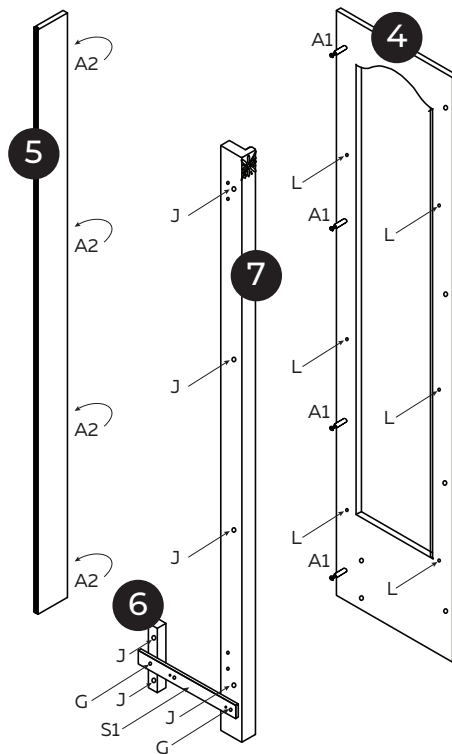
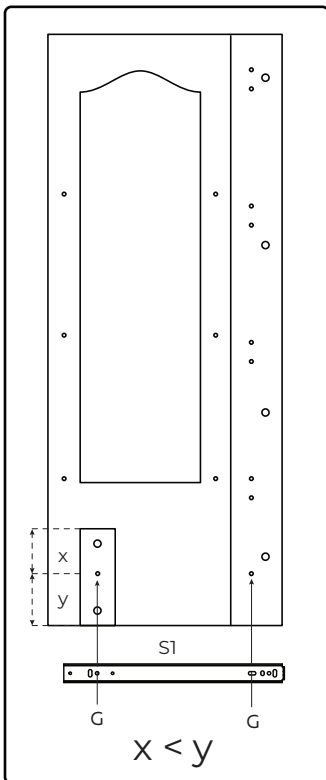

x2

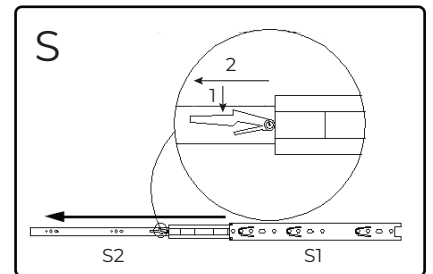

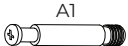

x2

A   x8

G  x4

J  x12

L  x12

S1  x2

2

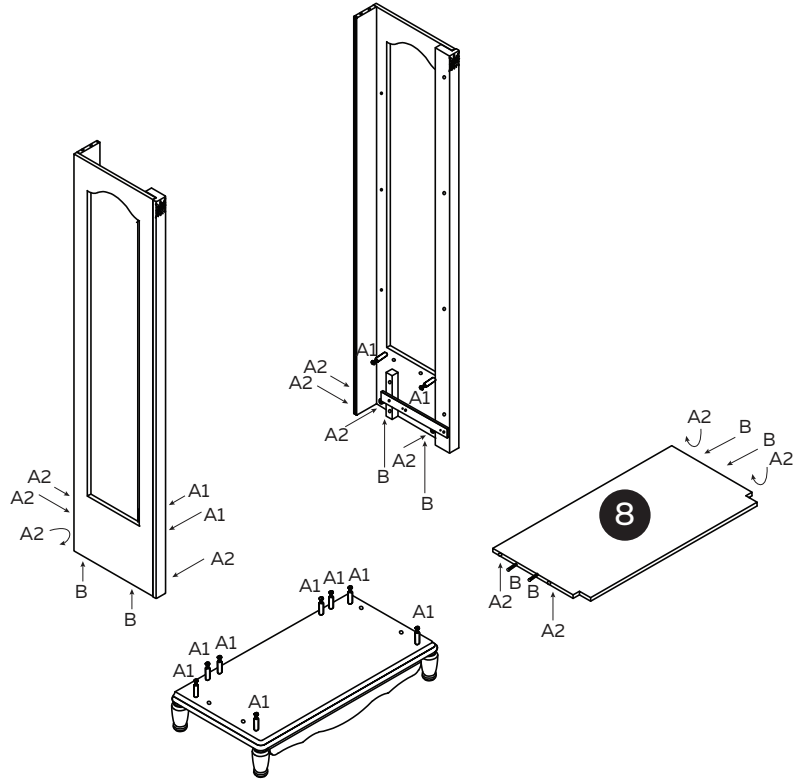
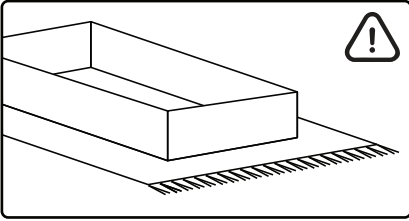

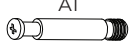
A   x12

B  x8

3

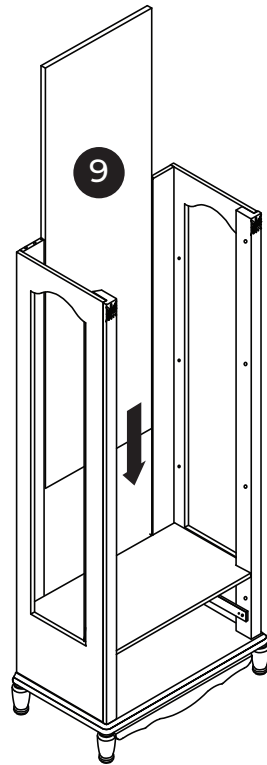
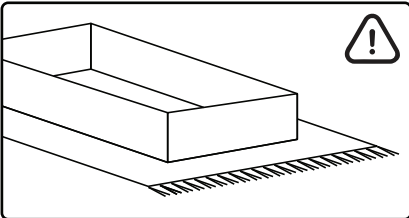

4

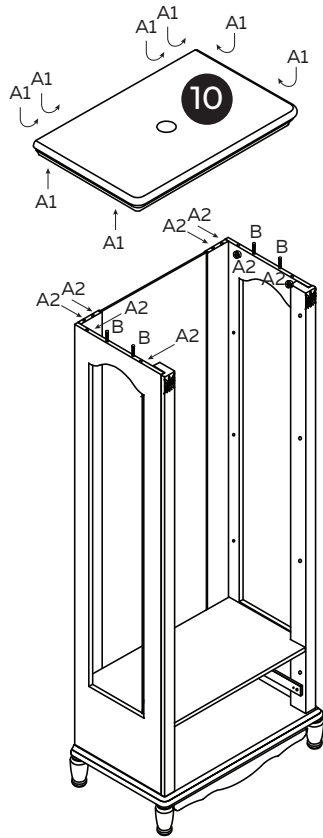
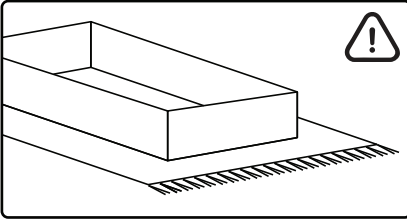

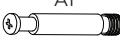
A   x8

B  x4

5

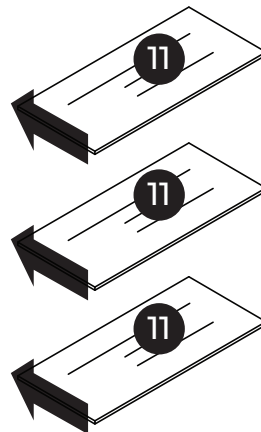
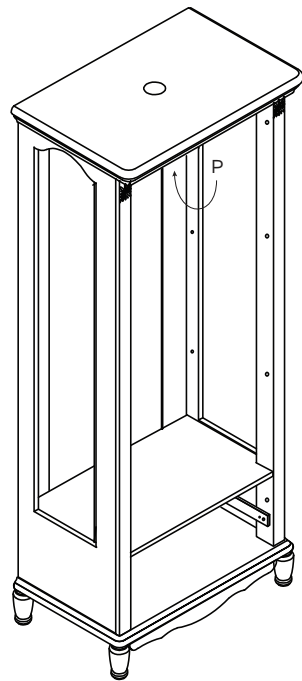

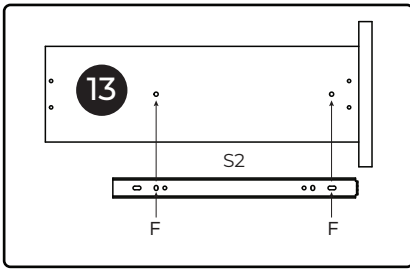

P  x1

6

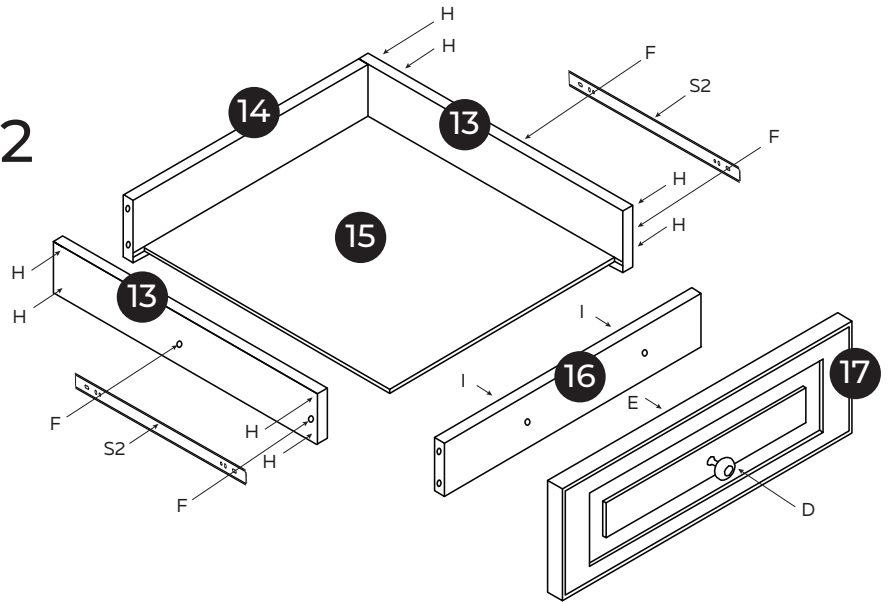
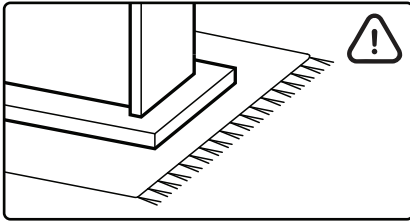

x2



D  x1

E  x1

F  x4

H  x8

I  x2

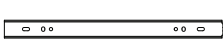
S2  x2

7

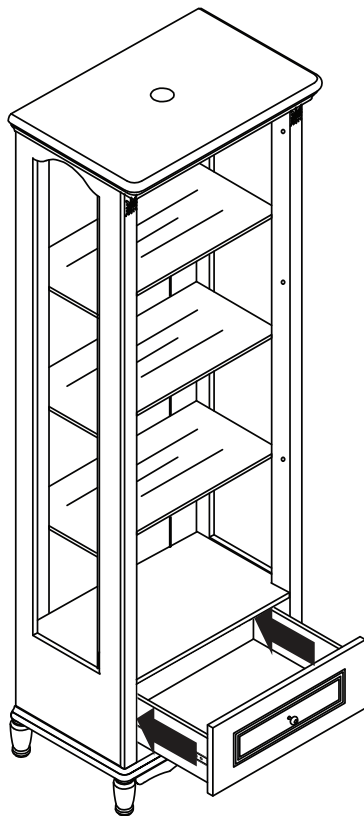

8

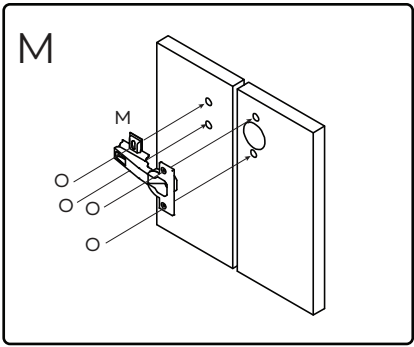

x4

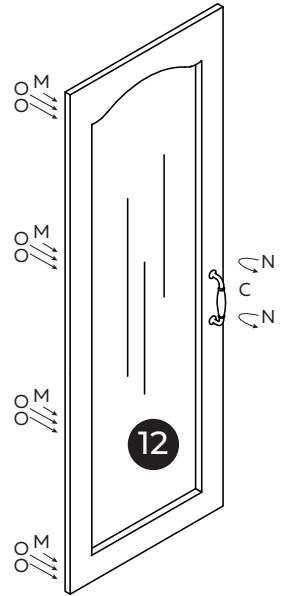
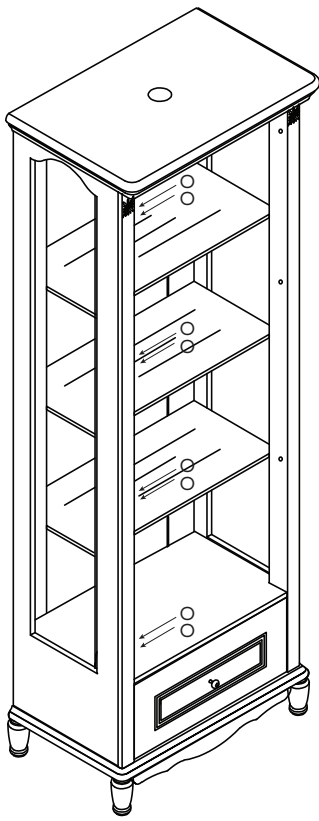

C  x1

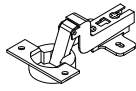
M  x4

N  x2

O  x16

9

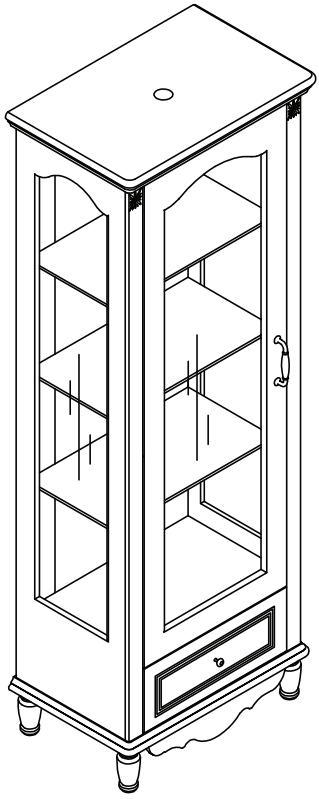

10